

310 003 000

Complete timing set for Renault 16v.

INCLUDED:

Locking plate for the new Renault petrol engines.

**Models:**

Renault: Clio, Clio Sport, Megane, Megane Scenic, Vel Satis, Avantime, Kangoo, Laguna, Espace.

Nissan: Note, Qashqai.

Engines: petrol: 1.4, 1.6, 1.8, 2.0 16V.

Codes: K4J/K4M, F4P/F4R.

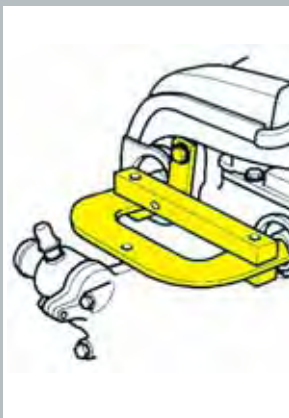
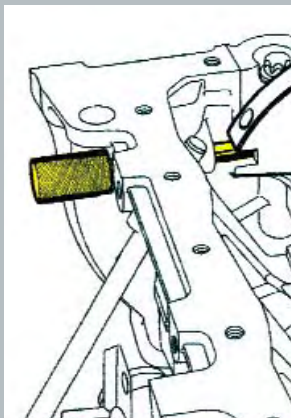
**310 073 000**

Set of tools for crankshaft timing on Renault 16v gasoline engines + locker for distribution pulleys on 1.4 — 1.6 16v.

INCLUDED:

Locking plate for the new Renault petrol engines.

**Models:**

Renault: Clio, Clio sport, Megane, Scénic, Laguna, Espace.

Nissan: Note, Qashqai

Engines: 1.4 - 1.6 16v, 1.8 16v, 2.0 16v

Codes: K4J 712/713/750, K4M 700/701/720/724/748, F4P760, F4R 700/701/730/740/741/744/780

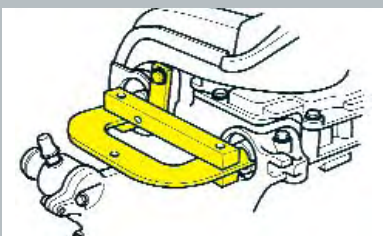
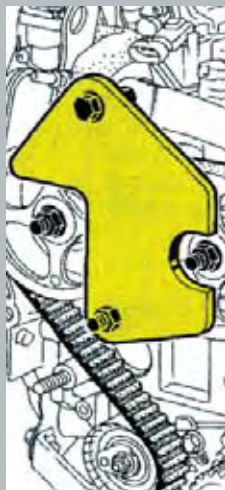
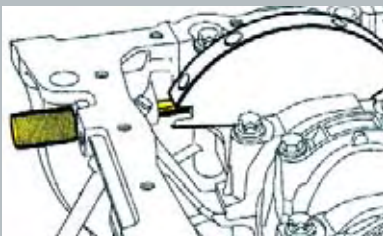
**Timing tools**



Timing tools



310 083 000

Complete set for camshaft and crankshaft timing on Renault diesel engines.

Cassetta fasatura albero motore, albero camme motori Renault diesel.

Models:

Renault: Laguna, Espace, Master, Clio, Kangoo

Nissan: Micra, Interstar, Primastar, Qashqai.

Engines: 1.5 dCi, , 2.2 dCi, 2.2/2.5 dCi.

Codes: G9T710/720, G9U ,K9K dal 2001, G9U 730, G9T722/750, G9U 720/724/726/750/754

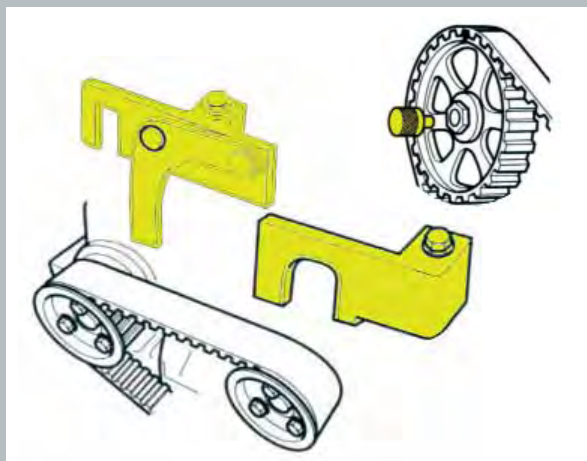

Timing tools



310 090 000

Set for crankshaft and camshaft timing on Renault diesel engines.

Cassetta fasatura albero motore, albero camme motori Renault diesel.

Models:

Renault: Laguna, Espace, Master.

Nissan: Interstar, Primastar.

Engines: 2.2dCi, 2.5dCi.

Codes: G9T710/720, G9U, G9T710/720, G9U, G9U 730, G9T722/750, G9U 720/724/726/750/754.

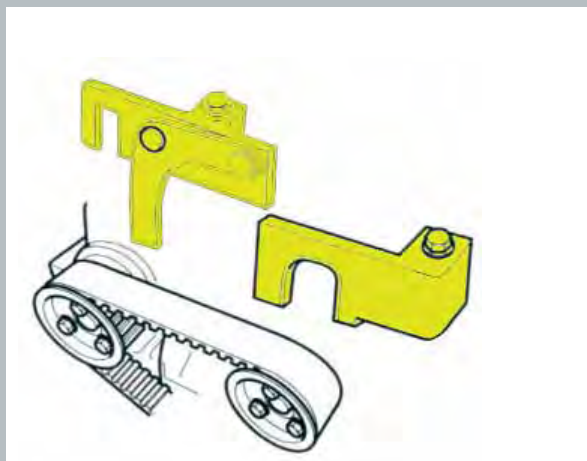

310 091 000

Complete set for camshaft and crankshaft timing on Renault diesel engines.

Cassetta fasatura albero motore, albero camme motori Renault diesel.

Models:

Renault: Mégane/Scénic, Laguna, Trafic, Twingo, Clio, Kangoo.

Nissan: Qashqai, Kubistar, Interstar.

Volvo: S40 / V40.

Engines: 1.9 TD, 1,9, 1.9 DCi, 1.2, 1.2 16V.

Codes:

F9Q 732, F9Q 718, F9Q 760, F9Q 732, F9Q 750, F9Q 754, 4192T3/4, D7F700/701/703/710/730 (1995-06)D4F, 702/704/706/708/712/714/716/730 (2000-06), D7F726, D4F 712, F9Q, 772/774.

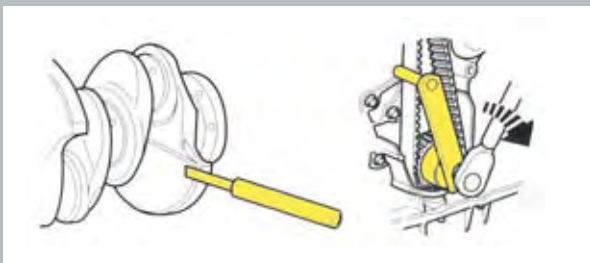
**Timing tools****310 092 000**

Set for crankshaft and camshaft timing on Renault diesel engines.

Cassetta fasatura albero motore, albero camme motori Renault diesel.

Models:

Renault: Clio, Kangoo.

Nissan: Kubistar, Micra, Note, Qashqai

Engines: 1.5 dCi.

Codes: K9K from 2001, K9K 702/704/710.

**Timing tools**



Timing tools



310 096 000

Set for camshaft and crankshaft timing on 1.5 timing on 1.5 diesel and petrol Renault engines.

INCLUDED:

Locking plate for the new Renault petrol engines.

**Models:**

Renault: Clio, Clio Sport, Megane, Megane Scenic, Vel Satis, Avantime, Kangoo, Laguna, Espace.

Nissan: Micra, Note, Qashqai.

Engines: Petrol: 1.4, 1.5 dCi, 1.6, 1.8, 2.0 16v.

Codes: K4J/K4M, F4P/F4R, K9K from 2001.

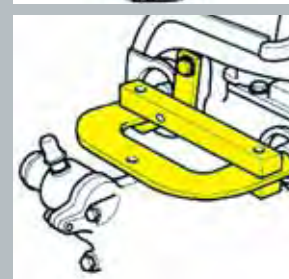
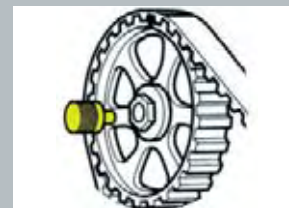
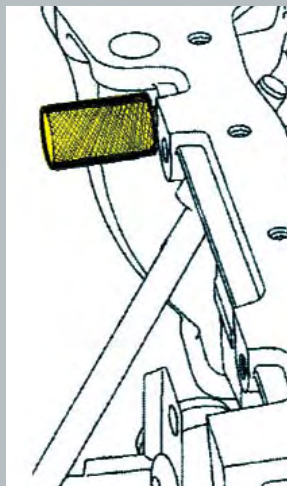

Timing tools



310 101 000

Complete set of tools suitable for timing, crankshaft locking, camshaft and pulleys locking on diesel engines.

Models:

Renault: Clio, Kangoo, Laguna, Espace, Master, Mégane/Scénic, Trafic.

Nissan: Kubistar, Interstar, Quashqai

Engines: 1.5 dCi, 1.9 TD, 1,9, 1,9 dCi, 2,2dCi, 2,5dCi.

Codes: K9K from 2001, F9Q 732, F9Q 718, F9Q 760, F9Q 732, F9Q 718, F9Q 760, F9Q 750, F9Q 754, G9T710/720, G9U.

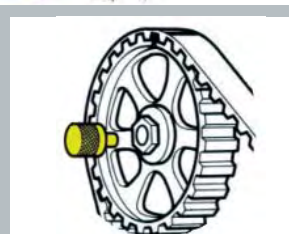
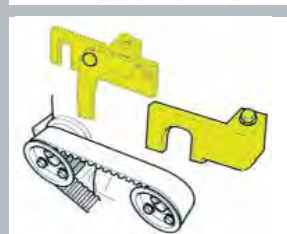
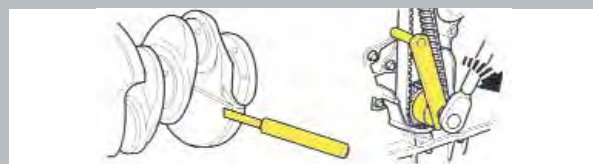

310 108 000

Complete set of tools suitable for timing, crankshaft locking, camshaft and pulleys locking on diesel and petrol engines.

INCLUDED:

Locking plate for the new Renault petrol engines.



Models: Clio, Clio Sport, Megane, Master, Mégane Scenic, Vel Satis, Avantime, Kangoo, Laguna, Espace, Trafic.

Engines: 1.2, 1.4, 1.5 dCi, 1.6, 16v, 1.6D, 1.7, 1.8, 1.816v, 1.9 TD, 1.9, 1.9 dCi, 2.0 16v., 2.1TD, 2.2 dCi, 2.2TD, 2.5 dCi, 2.5 TD, 2.8 D.

Codes:

D7F, E5F, E6J, E7F & E7J, K4J/K4M, K7M, F4P/F4R, K4J 712/713/750, K4M 700/701/720/724/748, F1N, F2N, F3N, F2R, F3P, F4P, f3r, 760, F4R700/701/730/740/741/744/780, G9T710/720, G9U, K9Kdal 2001, F9Q 732, F9Q 718, F9Q 760, F9Q 732, F9Q718, F9Q 760, F9Q 732, F9Q 718, F9Q 760, F9Q 750, F9Q 754, J5T, J6R, J7R, J7, F7PT, N7Q, N7U, F8M, F8Q, F9Q, J8S, G8TG8, S8U, S9U, S9WT.

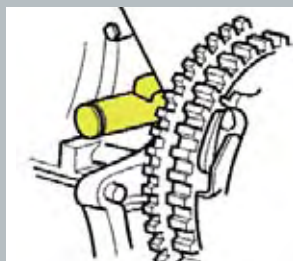
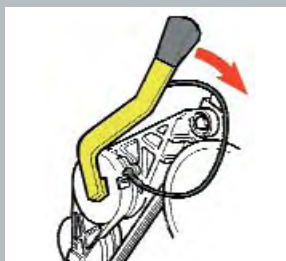
**Timing tools****310 113 000**

Complete set for Renault petrol and diesel engines.

INCLUDED:

Locking plate for the new Renault petrol engines.

**Petrol:**

1.2(D7F), 1.4(E5F, E6J, E7F & E7J), 1.6(K7M), 1.7-1.8 (F1N, F2N, F3N, F2R, F3P), 2.0(f3r), 2.0-2.2 (J5T, J6R, J7R, J7T)

Twin Cams: 1.4-1.6, 1.8-2.0 (F7P, F7R), 2.0-2.5 (N7Q, N7U)

Diesel:

1.6D-1.9D/TD (F8M, F8Q, F9Q), 2.1TD (J8S), 2.2D/TD (G8T), 2.5D/TD-2.8D (S8U, S9U, S9W)

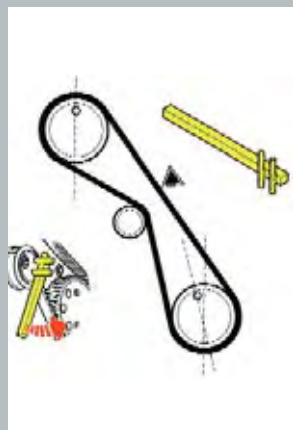
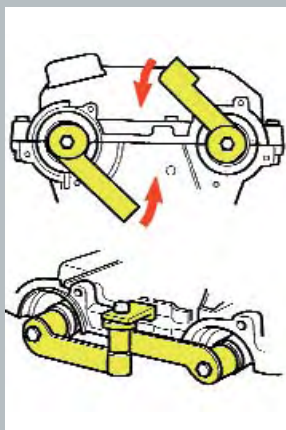
**Timing tools**

NEW PRODUCT

Timing tools



310 135 000

Complete set of tools suitable for timing: crankshaft and camshaft locking on new Renault 1.8, 2.0 petrol engines.

Kit per il bloccaggio albero motore e a camme dei nuovi motori benzina Renault 1.8, 2.0.

Models: Megane (99-03), Laguna 2 (01-05).

Engines: 1.8, 2.0 16V. IDE - 5FR (belt).

Codes: F5R, 700, 701, 740.

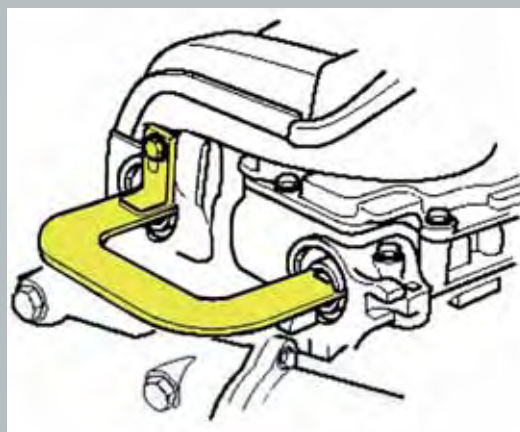

NEW PRODUCT

Timing tools



310 138 000

Complete set of timing tools suitable for crankshaft and camshaft locking on new Renault 2.0 dCi diesel engines.

Models:

Renault: Megane (07-08), Scenic (08-), Laguna (05-08), Vel Satis (08-), Espace (08-), Koleos (08-), Trafic (07-08).

Engines: 2.0 dCi (chain).

Codes: 700,722,724,740,742,446,760,761,780,802,803, 805,830,832,833.

Models:

Nissan: Qashquai (08-), X-Trail (07-08), Primastar (08-).

Engines: 2.0 dCi (chain.)

Codes: M9R 780, 830, 832, 833.

Kit suitable also for Vauxall / Opel models.

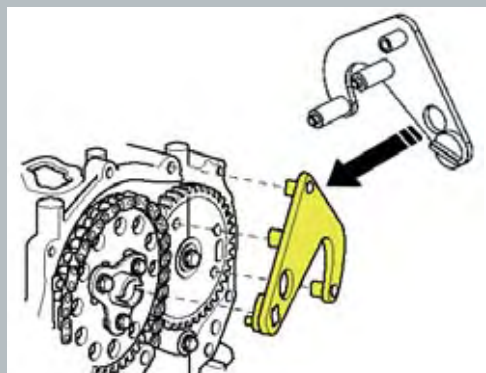

313 193 000

Plate for Renault petrol engines 1.4-1.6-1.8-2.0 16v.

Engines: 1.4, 1.6 16v.

Codes: K4M 716-760- 761-764-766-782-790-791- 792-800-801-802-804-812-813 K4J 770-780-780

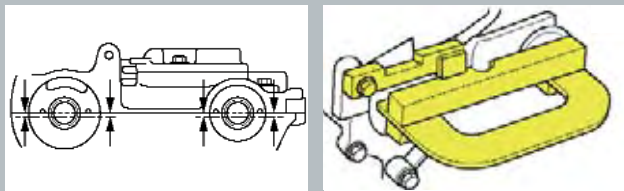

Timing tools

NEW PRODUCT

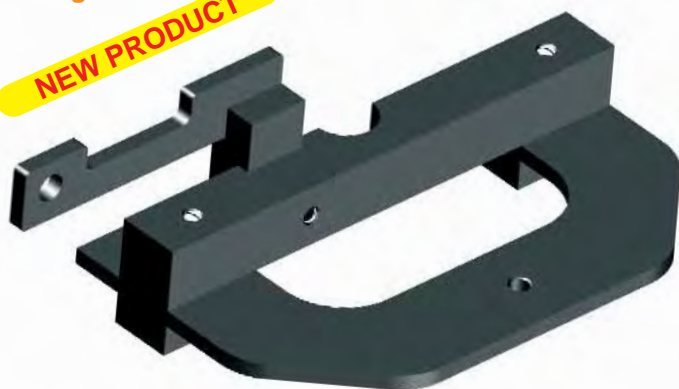
**313 170 000**

Timing tool for Renault petrol engines from 2001 on.

Models: Megane (99-03), Laguna 2 (01-05).

Engines: 1.8, 2.0 16v. IDE - 5FR (Belt)

Codes: F5R, 700, 701, 740

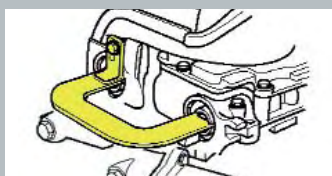

Timing tools

NEW PRODUCT

**313 188 000**

Timing tools for camshaft pulleys suitable for Renault diesel engines.

Piastra per pulegge camme Renault motori diesel.

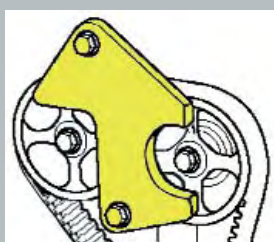

Timing tools

NEW PRODUCT

**314 021 000**

Special tool for head centering on Renault engines.

Attrezzo per centraggio testate, motori Renault.

Special tools

**316 007 000**

Belt extractor of air-conditioning and auxiliary system on Renault engines.

Attrezzo smontaggio cinghia clima-ausiliari motori Renault.

Special tools

