

SÚ NEVYHNUTNÝM VYBAVENÍM PRE MODERNÉ AUTODIELNE PRACUJÚCE
V SÚLADE SO ŽIVOTNÝM PROSTREDÍM, ČISTO A EFEKTÍVNE.
SÚ ZKONŠTRUOVANÉ Z KVALITNEJ OCELE S VYSOKOU HUSTOTOU
POLYPROPYLENOVÝCH HADÍC V BUBNI PRE DLHÚ ŽIVOTNOSŤ
TIETO NAVIJAKY SÚ ROBUSTNÉ A URČENÉ PRE NÁROČNÚ PRÁCU V PREVÁDZKACH

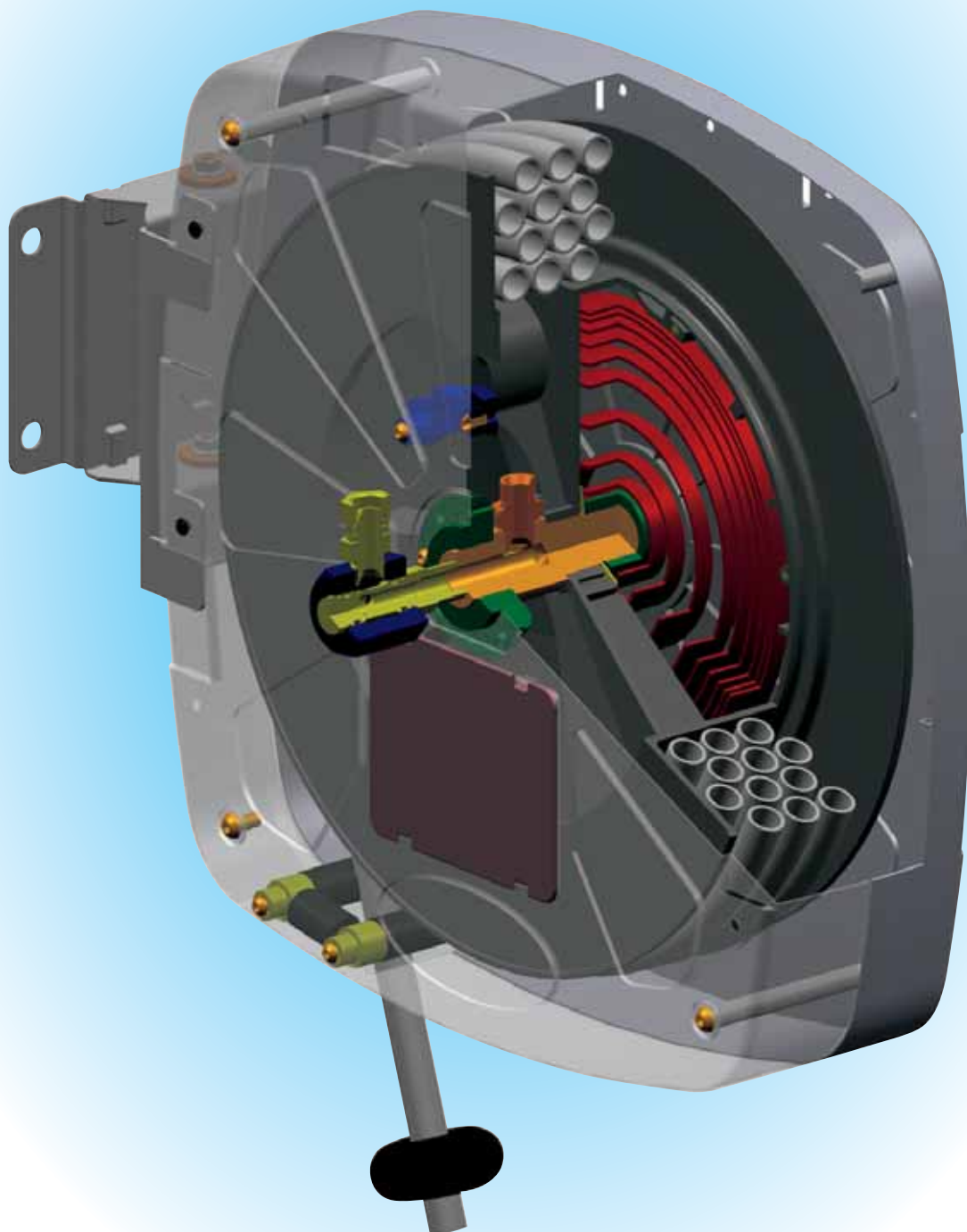

HADICOVÉ NAVIJAKY "TYP ŠTANDARD"

RA 2001

UZAVRETÝ NAVIJAK BEZ HADICE



RA 2002

OTVORENÝ NAVIJAK BEZ HADICE



VA 9001

OTOČNÝ DRŽIAK
NA STENU

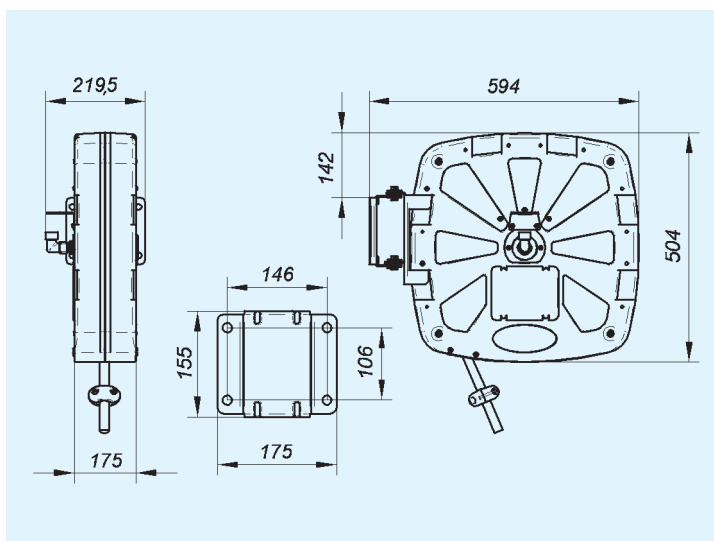

CELKOVÉ ROZMERY UZAVRETÉHO NAVIJAKA

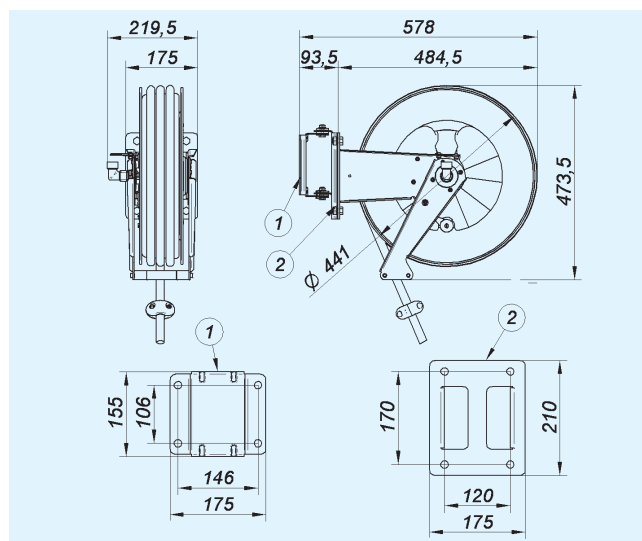

CELKOVÉ ROZMERY OTVORENÉHO NAVIJAKA



OTVORENÝ NAVIJAK NA STENU
MOŽNOSŤ A



OTVORENÝ NAVIJAK NA STENU
MOŽNOSŤ B







OTVORENÝ NAVIJAK
NA STROP

HADICOVÉ NAVIJAKY "TYP ŠTANDARD"

HADICOVÉ
NAVIJAKY





PRE NOVÝ OLEJ

Hadicové navijaky je možné objednať s rôznou dĺžkou, s rôznym priemerom hadíc a uchytením navijaka podľa požiadavky

							
		RA 2001	NA 2001	NA 2002	RA 2002	NA 2101	NA 2102
PRACOVNÝ TLAK	BAR	80	80	80	80	80	80
PRACOVNÝ TLAK	PSI	1160	1160	1160	1160	1160	1160
DĹŽKA HADÍC	m	—	10	15	—	10	15
	ft	—	33	50	—	33	50
PRIEMER HADÍC		—	1/2"	1/2"	—	1/2"	1/2"
DĹŽKA SPOJOVACEJ HADICE	m	—	0,6	0,6	—	0,6	0,6
	ft	—	2'	2'	—	2'	2'
SPOJENIE VSTUP		—	1/2" BSP/F	1/2" BSP/F	—	1/2" BSP/F	1/2" BSP/F
SPOJENIE VÝSTUP		—	1/2" BSP/F	1/2" BSP/F	—	1/2" BSP/F	1/2" BSP/F
MAX. DĹŽKA HADÍC 3/8"	m	18	—	—	18	—	—
	ft	60	—	—	60	—	—
MAX. DĹŽKA HADÍC 1/2"	m	15	—	—	15	—	—
	ft	50	—	—	50	—	—
VÁHA	 KG	20,5	24,5	25,5	19	23	24
ROZMERY BALENIA	 mm	540 x 610 x 240			460 x 550 x 240		





PRE MAZACIE TUKY

Hadicové navijaky je možné objednať s rôznou dĺžkou, s rôznym priemerom hadíc a uchytením navijaka podľa požiadavky

							
		RA 2005	GA 2001	GA 2002	RA 2006	GA 2101	GA 2102
PRACOVNÝ TLAK	BAR	600	600	600	600	600	600
PRACOVNÝ TLAK	PSI	8700	8700	8700	8700	8700	8700
DĹŽKA HADÍC	m	—	10	15	—	10	15
	ft	—	33	50	—	33	50
PRIEMER HADÍC		—	1/4"	1/4"	—	1/4"	1/4"
DĹŽKA SPOJOVACEJ HADICE	m	—	0,6	0,6	—	0,6	0,6
	ft	—	2'	2'	—	2'	2'
SPOJENIE VSTUP		—	1/4" BSP/F	1/4" BSP/F	—	1/4" BSP/F	1/4" BSP/F
SPOJENIE VÝSTUP		—	1/2" BSP/F	1/2" BSP/F	—	1/2" BSP/F	1/2" BSP/F
MAX. DĹŽKA HADÍC 1/4"	m	20	—	—	20	—	—
	ft	66	—	—	66	—	—
VÁHA	 KG	20,5	24	25	19	22,5	23,5
ROZMERY BALENIA	 mm	540 x 610 x 240			460 x 550 x 240		

PRE VZDUCH/VODU

Hadicové navijaky je možné objednať s rôznou dĺžkou, s rôznym priemerom hadíc a uchytením navijaka podľa požiadavky

							
		RA 2001	AA 2001	AA 2002	RA 2002	AA 2101	AA 2102
PRACOVNÝ TLAK	BAR	80	18	18	80	18	18
PRACOVNÝ TLAK	PSI	1160	260	260	1160	260	260
DĹŽKA HADÍC	mt	—	10	15	—	10	15
	ft	—	33	50	—	33	50
PRIEMER HADÍC		—	3/8"	3/8"	—	3/8"	3/8"
DĹŽKA SPOJOVACEJ HADICE	mt	—	0,6	0,6	—	0,6	0,6
	ft	—	2'	2'	—	2'	2'
SPOJENIE VSTUP		—	1/2" BSP/F	1/2" BSP/F	—	1/2" BSP/F	1/2" BSP/F
SPOJENIE VÝSTUP		—	1/2" BSP/F	1/2" BSP/F	—	1/2" BSP/F	1/2" BSP/F
MAX. DĹŽKA HADÍC 1/4"	mt	18	—	—	18	—	—
	ft	60	—	—	60	—	—
VÁHA	 KG	20,5	24	25	19	22,5	23,5
ROZMERY BALENIA	 mm	540 x 610 x 240			460 x 550 x 240		

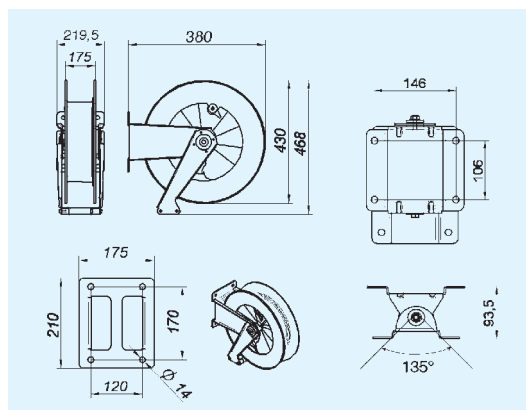





RA 2012



VA 9001

OTOČNÝ
DRŽIAK NA STENU

		 PRE NOVÝ OLEJ			 PRE MAZACIE TUKY			 PRE VZDUCH /VODU		
		RA 2012	NA 2103	NA 2104	RA 2014	GA 2110	GA 2111	RA 2012	AA 2110	AA 2111
PRACOVNÝ TLAK	BAR	80	80	80	600	600	600	80	18	18
PRACOVNÝ TLAK	PSI	1160	1160	1160	8700	8700	8700	1160	260	260
DĹŽKA HADÍC	m	—	7	10	—	7	10	—	7	10
	ft	—	23	33	—	23	33	—	23	33
PRIEMER HADÍC		—	1/2"	3/8"	—	1/4"	1/4"	—	3/8"	3/8"
DĹŽKA SPOJOVACEJ HADICE	m	—	0,6	0,6	—	0,6	0,6	—	0,6	0,6
	ft	—	2'	2'	—	2"	2"	—	2"	2"
SPOJENÝ VSTUP		1/2 BSP/F	1/2" BSP/F	1/2" BSP/F	1/4" BSP/F	1/4" BSP/F	1/4" BSP/F	1/2" BSP/F	1/2" BSP/F	1/2" BSP/F
SPOJENÝ VÝSTUP		3/8 BSP/F	1/2" BSP/F	3/8" BSP/F	1/4" BSP/F	1/4" BSP/F	1/4" BSP/F	3/8" BSP/F	3/8" BSP/F	3/8" BSP/F
MAX. DĹŽKA HADÍC 3/8"		10 m - 33 ft	—	—	10 m - 33 ft	—	—	10 m - 33 ft	—	—
MAX. DĹŽKA HADÍC 1/2"		7m - 23 ft	—	—						
MAX. DĹŽKA HADÍC 1/4"										
VÁHA	 KG	12,00	15,00	15,20	12,00	14,50	15,50	12,00	14,50	15,50
ROZMERY BALENIA	 mm	460 x 460 x 270			460 x 460 x 270			460 x 460 x 270		

podľa požiadaviek je možné objednať hadice rôznych dĺžok a priemeru

NAVIJAKY PRE VYSOKÝ TLAK A VEĽKÝ OBJEM

HADICOVÉ
NAVIJAKY

"TYP ŤAŽKÝ"

VYSOKÝ OBJEM 3/4"- 1"
NAVIJAKY SÚ VYROBENÉ Z KVALITNEJ OCELE PRE ŤAŽKÚ PRÁCU A DLHÚ ŽIVOTNOSŤ. SÚ DODÁVANÉ S HADICAMI ALEBO BEZ NICH

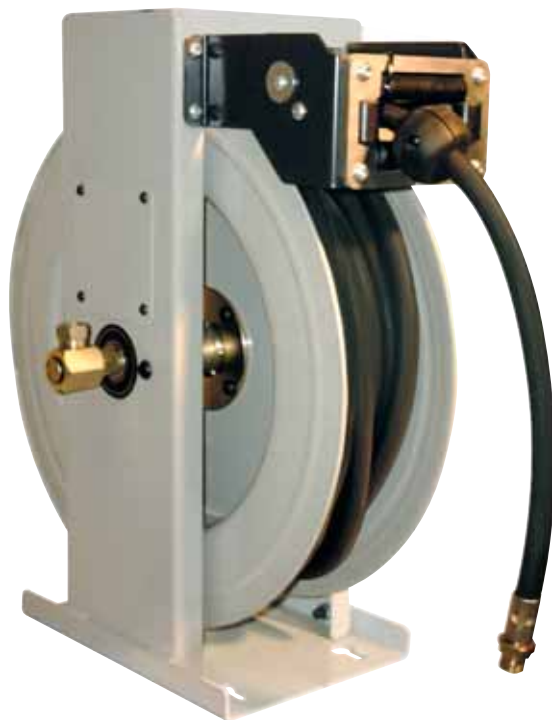
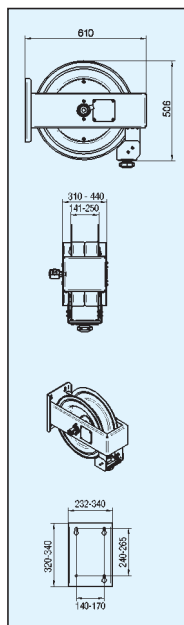

RA 2003

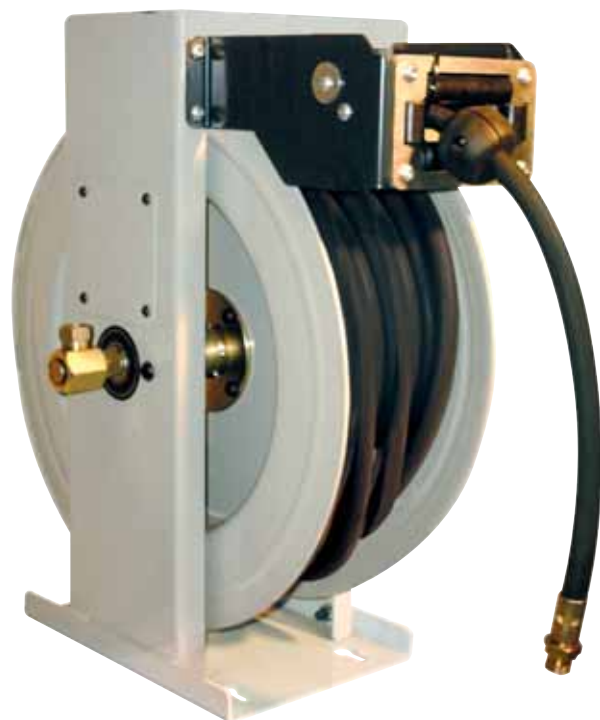

RA 2004

		VYSOKÝ TLAK							VÝSOKÝ OBJEM			
		OLEJ			TUKY				RA2004	NA2301	NA2302	NA2303
		RA2003	NA2201	NA2202	RA2015	GA2201	GA2202	GA2203				
PRACOVNÝ TLAK	BAR	80	80	80	400	350	250	250	80	60	60	60
	PSI	1160	1160	1160	5800	5075	3625	3625	1160	870	870	870
PRACOVNÝ TLAK	m	—	20	25	—	20	15	20	—	14	15	20
	ft	—	66'	82'	—	66'	50'	66'	—	46'	50'	66'
DĹŽKA HADÍC		—	1/2"	1/2"	—	3/8"	1/2"	1/2"	—	1"	3/4"	3/4"
DĹŽKA SPOJOVACEJHADICE	m	—	0,6	0,6	—	0,6	0,6	0,6	—	0,6	0,6	0,6
	ft	—	2'	2'	—	2'	2'	2'	—	2'	2'	2'
SPOJENÝ VSTUP		—	1/2" BSP/F	1/2" BSP/F	—	1/2" BSP/F	1/2"	1/2"	—	1" BSP/F	1" BSP/F	1" BSP/F
SPOJENÝ VÝSTUP		—	1/2" BSP/F	1/2" BSP/F	—	1/2" BSP/F	1/2"	1/2"	—	1" BSP/F	1" BSP/F	1" BSP/F
MAX. DĹŽKA HADÍC 1/2"	m	25	—	—	—	—	—	—	—	—	—	—
	ft	82	—	—	—	—	—	—	—	—	—	—
MAX. DĹŽKA HADÍC 3/4"	m	—	—	—	—	—	—	—	20	—	—	—
	ft	—	—	—	—	—	—	—	66	—	—	—m
		—	—	—	—	—	—	—	14	—	—	—
MAX. DĹŽKA HADÍC 1 "	ft	—	—	—	—	—	—	—	46	—	—	—
VÁHA	KG	33,50	41,50	43,50	33,50	—	—	—	45,00	61,00	56,00	60,00
ROZMERY BALENIA		650 x 550 x 330			650 x 550 x 330				600 x 500 x 680			

"TYP ŠTANDARD"

VYSOKÝ TLAK 1/2"

VYSOKÝ OBJEM 3/4" - 1"

NAVIJAKY SÚ VYROBENÉ Z KVALITNEJ OCELE PRE ŤAŽKÚ PRÁCU A DLHÚ ŽIVOTNOSŤ.
SÚ DODÁVANÉ S HADICAMI ALEBO BEZ NICH



VA 9003

OTOČNÝ
DRŽIAK NA STENU



RA 2010

RA 2011

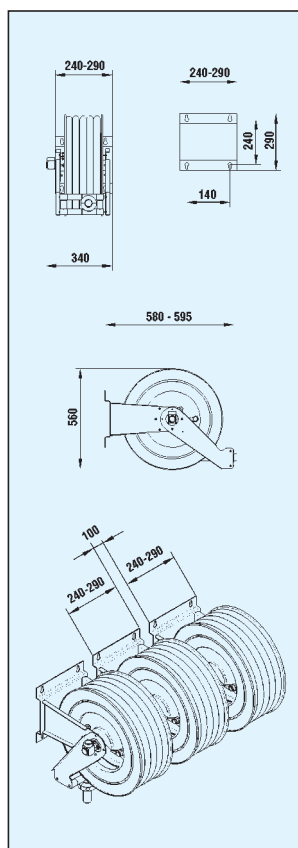

		VYSOKÝ TLAK			VÝSOKÝ OBJEM		
		RA 2010	NA 2403	NA 2401	RA 2011	NA 2501	NA 2502
PRACOVNÝ TLAK	BAR	80	80	80	80	60	60
	PSI	1160	1160	1160	1160	870	870
PRACOVNÝ TLAK	m	—	15	20	—	14	20
	ft	—	50	82	—	46	66
DĹŽKA HADÍC		—	3/4"	1/2"	—	1"	3/4"
DĹŽKA SPOJOVACEJ HADICE	m	—	0,6	0,6	—	0,6	0,6
	ft	—	2'	2'	—	2'	2'
SPOJENÝ VSTUP		—	1/2" BSP/F	1/2" BSP/F	—	1" BSP/F	1" BSP/F
SPOJENÝ VÝSTUP		—	1/2" BSP/F	1/2" BSP/F	—	1" BSP/F	1" BSP/F
MAX. DĹŽKA HADÍC 1/2"	m	20	—	—	—	—	—
	ft	82	—	—	—	—	—
MAX. DĹŽKA HADÍC 3/4"	m	15	—	—	20	—	—
	ft	50	—	—	66	—	—
MAX. DĹŽKA HADÍC 1"	m	—	—	—	14	—	—
	ft	—	—	—	46	—	—
VÁHA	KG	25,00	37,00	34,00	29,00	45,00	44,00
ROZMERY BALENIA		610 x 350 x 610			610 x 390 x 650		

NEREZOVÉ HADICOVÉ NAVIJAKY

HADICOVÉ
NAVIJÁKY

VA 9002



OTOČNÝ DRŽIAK
NA STENU
pre RA2007

VA 9004



OTOČNÝ DRŽIAK
NA STENU
pre RA2008 – RA2013



RA 2007

OTVORENÝ HADICOVÝ NAVIJAK
PEVNÝ/OTOČNÝ
TYP ŠTANDARD
BEZ HADICE



RA 2008

OTVORENÝ HADICOVÝ NAVIJAK
PEVNÝ/OTOČNÝ
VYSOKÝ TLAK
BEZ HADICE



RA 2013

OTVORENÝ HADICOVÝ NAVIJAK
PEVNÝ/OTOČNÝ
VYSOKÝ OBJEM

pre rozmery otočte na stranu 62

pre rozmery otočte na stranu 66

		RA2007	LA2101	LA2102	LA2103	LA2104	RA2008	LA2201	LA2202	LA2203	LA2204	LA2205	LA2206	RA2013	LA2301	LA2302
PRACOVNÝ TLAK	BAR	200	200	200	200	200	200	200	200	200	200	200	200	80	60	60
	PSI	2900	2900	2900	2900	2900	2900	2900	2900	2900	2900	2900	2900			
PRACOVNÝ TLAK	mt	—	10	15	10	15	—	25	20	25	25	20	25	—	20	14
	ft	—	33'	50'	33'	50'	—	82'	66'	82'	82'	66'	82'	—	66'	46'
DĹŽKA HADÍC		—	3/8"	3/8"	3/8"	3/8"	—	3/8"	1/2"	1/2"	3/8"	1/2"	1/2"	—	3/4"	1"
DĹŽKA SPOJOVACEJ HADICE	m	—	0,6	0,6	0,6	0,6	—	0,6	0,6	0,6	0,6	0,6	0,6	—	0,6	0,6
	ft	—	2'	2'	2'	2'	—	2'	2"	2"	2"	2"	2"	—	2"	2"
SPOJENÝ VSTUP		1/2"	1/2"	1/2"	1/2"	1/2"	1/2"	1/2"	1/2"	1/2"	1/2"	1/2"	1/2"	1"	1"	1"
SPOJENÝ VÝSTUP		1/2"	1/2"	1/2"	1/2"	1/2"	1/2"	1/2"	1/2"	1/2"	1/2"	1/2"	1/2"	1"	1"	1"
MAX. DĹŽKA HADÍC 3/8 "	m	18	—	—	—	—	—	—	—	—	—	—	—	3/4"	20	—
	ft	60'	—	—	—	—	—	—	—	—	—	—	—	—	66'	—
MAX. DĹŽKA HADÍC 1/2 "	m	15	—	—	—	—	25	—	—	—	—	—	—	1"	—	1/4"
	ft	50'	—	—	—	—	82'	—	—	—	—	—	—	—	—	46'
VÁHA	KG	19,00	21,50	22,50	21,50	22,50	33,50	42,50	40,50	42,50	42,50	40,50	42,50	27,50	43,50	42,50
ROZMERY BALENIA		460 x 550 x 240					610 x 350 x 610					610 x 390 x 650				
HYGIENICKÉ						HYGIENICKÉ										

podľa požiadaviek je možné objednať
hadice rôznych dĺžok a priemerov



	TYP	PRIEMER					DĹŽKA	SPOJ	
		1/4"	3/8"	1/2"	3/4"	1"			
VH 9130	R1 AT	—	60 BAR	—	—	—	10	M/F 90°	OLEJ
VH 9201	R1 AT	—	—	60 BAR	—	—	0,6	M/F	
VH 9202	R1 AT	—	—	60 BAR	—	—	1	M/F	
VH 9203	R1 AT	—	—	60 BAR	—	—	2	M/F	
VH 9204	R1 AT	—	—	60 BAR	—	—	4	M/F	
VH 9205	R1 AT	—	—	60 BAR	—	—	10	M/F	
VH 9206	R1 AT	—	—	60 BAR	—	—	15	M/F	
VH 9207	R1 AT	—	—	60 BAR	—	—	20	M/F	
VH 9208	R1 AT	—	—	60 BAR	—	—	25	M/F	
VH 9209	R1 AT	—	—	60 BAR	—	—	0,6	M/F 90°	
VH 9210	R1 AT	—	—	60 BAR	—	—	7	M/F 90°	
VH 9301	R1 AT	—	—	—	60 BAR	—	0,6	M/F	
VH 9302	R1 AT	—	—	—	60 BAR	—	10	M/F	
VH 9303	R1 AT	—	—	—	60 BAR	—	15	M/F	
VH 9304	R1 AT	—	—	—	60 BAR	—	20	M/F	
VH 9305	R1 AT	—	—	—	60 BAR	—	2	M/F	
VH 9306	R1 AT	—	—	—	60 BAR	—	8	M/F	
VH 9308	R1 AT	—	—	—	60 BAR	—	4	M/F	
VH 9401	R1 AT	—	—	—	—	60 BAR	0,6	M/F	
VH 9402	R1 AT	—	—	—	—	60 BAR	14	M/F	
VH 9403	R1 AT	—	—	—	—	60 BAR	2	M/F	
VH 9001	R2 AT	600 BAR	—	—	—	—	0,6	M/F	TUKY
VH 9002	R2 AT	600 BAR	—	—	—	—	1,5	M/F	
VH 9003	R2 AT	600 BAR	—	—	—	—	4	M/F	
VH 9004	R2 AT	600 BAR	—	—	—	—	10	M/F	
VH 9005	R2 AT	600 BAR	—	—	—	—	15	M/F	
VH 9006	R2 AT	600 BAR	—	—	—	—	20	M/F	
VH 9008	R2 AT	600 BAR	—	—	—	—	7	M/F 90°	
VH 9101	TDP	—	18 BAR	—	—	—	0,6	M/F	
VH 9102	TDP	—	18 BAR	—	—	—	2	M/F	
VH 9103	TDP	—	18 BAR	—	—	—	4	M/F	
VH 9104	TDP	—	18 BAR	—	—	—	10	M/F	
VH 9105	TDP	—	18 BAR	—	—	—	15	M/F	
VH 9106	TDP	—	18 BAR	—	—	—	7	M/F 90°	
VH 9107	TDP	—	18 BAR	—	—	—	10	M/F 90°	
VH 9120	TDP	—	—	18 BAR	—	—	0,6	M/F	
VH 9121	TDP	—	—	18 BAR	—	—	10	M/F	
VH 9122	TDP	—	—	18 BAR	—	—	15	M/F	
VH 9151	R2 ATF	—	200 BAR	—	—	—	0,6	M/F	KAPALINY
VH 9152	R2 AT	—	200 BAR	—	—	—	10	M/F	
VH 9153	R2 AT	—	200 BAR	—	—	—	15	M/F	
VH 9154	R2 AT	—	200 BAR	—	—	—	25	M/F	
VH 9161	HYGIENICKÉ	—	200 BAR	—	—	—	10	M/F	
VH 9162	HYGIENICKÉ	—	200 BAR	—	—	—	15	M/F	
VH 9163	HYGIENICKÉ	—	200 BAR	—	—	—	25	M/F	
VH 9251	R2 AT	—	—	200 BAR	—	—	20	M/F	
VH 9252	R2 AT	—	—	200 BAR	—	—	25	M/F	
VH 9253	R2 AT	—	—	200 BAR	—	—	0,6	M/F	
VH 9263	HYGIENICKÉ	—	—	200 BAR	—	—	20	M/F	
VH 9264	HYGIENICKÉ	—	—	200 BAR	—	—	25	M/F	

HADICOVÉ A KÁBLOVÉ NAVIJAKY

HADICOVÉ
NAVIJAKY

AA 2901
AA 2902
AA 2903

AA 2904
AA 2905

AA 2906
AA 2907

AA 2909
AA 2910

AA 2908



VZDUCH		N x mm ²	∅			
AA 2901	navijak na vzduch-master 12		6 x 10 mm	12 mt	32x34x20	3,8 Kg
AA 2902	navijak na vzduch-master 9		* 8 x 12 mm	9 mt	32x34x20	4,6 Kg
AA 2903	navijak na vzduch-classic 10		6 x 10 mm	10 mt	29,5x30,5x16,5	3,5 Kg
AA 2904	navijak na vzduch-maxi 15		* 8 x 12 mm	15 mt	38x39x25	6,5 Kg
AA 2905	navijak na vzduch-maxi 10		10 x 15 mm	10 mt	38x39x25	6,5 Kg
AA 2906	navijak na vzduch-compact 12		* 8 x 12 mm	12 mt	36x33x20	4,4 Kg
AA 2907	navijak na vzduch-compact 15		6 x 10 mm	15 mt	36x33x20	4,4 Kg
AA 2908	navijak na vzduch-mini 6		6 x 8 mm	5+1 mt	23x20x14	1,2 Kg
AA 2909	navijak na vzduch-big 20		* 10 x 15 mm	20 mt	44x51x23	7,3 Kg
AA 2910	navijak na vzduch-big 16		12 x 18 mm	15+1 mt	44x51x23	7,4 Kg

pozn.: vhodné pre vzduch/vodu



WA 2901
WA 2902
WA 2903

WA 2904
WA 2905

WA 2916
WA 2917

WA 2918
WA 2919

ELEKTRICKÉ PREDĹŽENIE		N x mm ²	 WATT			
WA 2901	Reel power 220/15	2 x 1,0 mm	800/2000	15 mt	29,5x30,5x16,5	4,5 Kg
WA 2902	Reel power 220/10 TUV	3 x 1,5 mm	800/2000	10 mt	29,5x30,5x16,5	4,5 Kg
WA 2903	Reel power 220/10 Schuko TUV	3 x 1,5 mm	800/2000	10 mt	29,5x30,5x16,5	4,5 Kg
WA 2904	Reel compact 220/20	2 x 1,0 mm	800/2000	20 mt	36x33x20	4,5 Kg
WA 2905	Reel compact 220/18 TUV	3 x 1,5 mm	800/2000	18 mt	36x33x30	4,8 Kg
WA 2916	Mini Reel TUV	3 x 1,5 mm	800/2000	5+1 mt	23x20x15	4,8 Kg
WA 2917	Big Reel SCHUKO TUV	3 x 1,5 mm	800/2000	5+1 mt	23x20x15	4,8 Kg
WA 2918	Big Reel TUV	3 x 1,5 mm	800/2000	35 mt	44x51x23	4,8 Kg
WA 2919	Big Reel TUV	5 x 1,5 mm	1000/3000	30 mt	44x51x23	11,6 Kg

AUTOMATICKÉ KÁBLOVÉ NAVIJAKY





WA 2906

WA 2907

WA 2908

WA 2909







NEON		N x mm ²	 / 			
Model	Description					
WA 2906	navijak-neon 220/15	2 x 1 mm	2G7/9W	15 mt	29,5x30,5x16,5	4,8 Kg
WA 2907	navijak-neon 24 volt	2 x 1 mm	2G7/11W	15 mt	29,5x30,5x22,5	5,5 Kg
WA 2908	navijak-compact neon 220/20	2 x 1 mm	2G7/9W	20 mt	36x33x30	5,0 Kg
WA 2909	navijak-compact neon 24 volt	2 x 1 mm	2G7/11W	20 mt	36x33x30	5,7 Kg



WA 2910
WA 2911
WA 2912



WA 2913
WA 2914
WA 2915

LAMPY		N x mm ²	 / 			
Model	Description					
WA 2910	navijak-lampa 220/15	2 x 1 mm	E27/60W	15 mt	29,5x30,5x22,5	4,5 Kg
WA 2911	navijak-lampa 12 V	2 x 1 mm	E27/60W	15 mt	29,5x30,5x22,5	6,7 Kg
WA 2912	navijak-lampa 24V	2 x 1 mm	E27/60W	15 mt	29,5x30,5x22,5	6,7 Kg
WA 2913	navijak-lampa compact 220 V	2 x 1 mm	E27/60W	20 mt	36x33x30	5,0 Kg
WA 2914	navijak-lampa compact 12 V	2 x 1 mm	E27/60W	20 mt	36x33x30	6,1 Kg
WA 2915	navijak-lampa compact 24 V	2 x 1 mm	E27/60W	20 mt	36x33x30	6,1 Kg

PRÍSLUŠENSTVO

VV 9016

ZÁVESNÁ NEONOVÁ
LAMP
S 10 M KÁBLOM

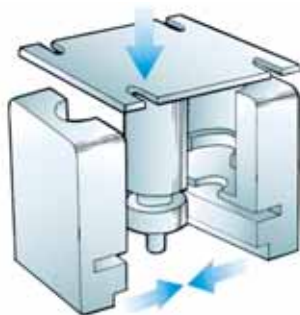

VV 9015

DRŽIAK NA STENU
PRE NAVIJAKY

VODA



LA 2901

AUTOMATICKÝ HADICOVÝ
NAVIJAK NA VODU

**V 0195**

PRENOSNÁ LED LAMPA

ZLOŽENÁ Z:

Nabíjača batérií

Gumového krytu proti vode/oleju

Držadla nastaviteľného všetkými smermi

Blikajúceho svetla pre prípad nebezpečia

červené kontrolky signalizujúce vybitie batérií

Čas pre úplné nabitie batérií: 5 hodín

Držiaka na inštaláciu na stenu

Krytie IP65

Nabíjací čas okolo 2,5 hod.