



Systems Catalogue

BenchRack

Concept of Collision Repair Systems



* = Recommended Quantity

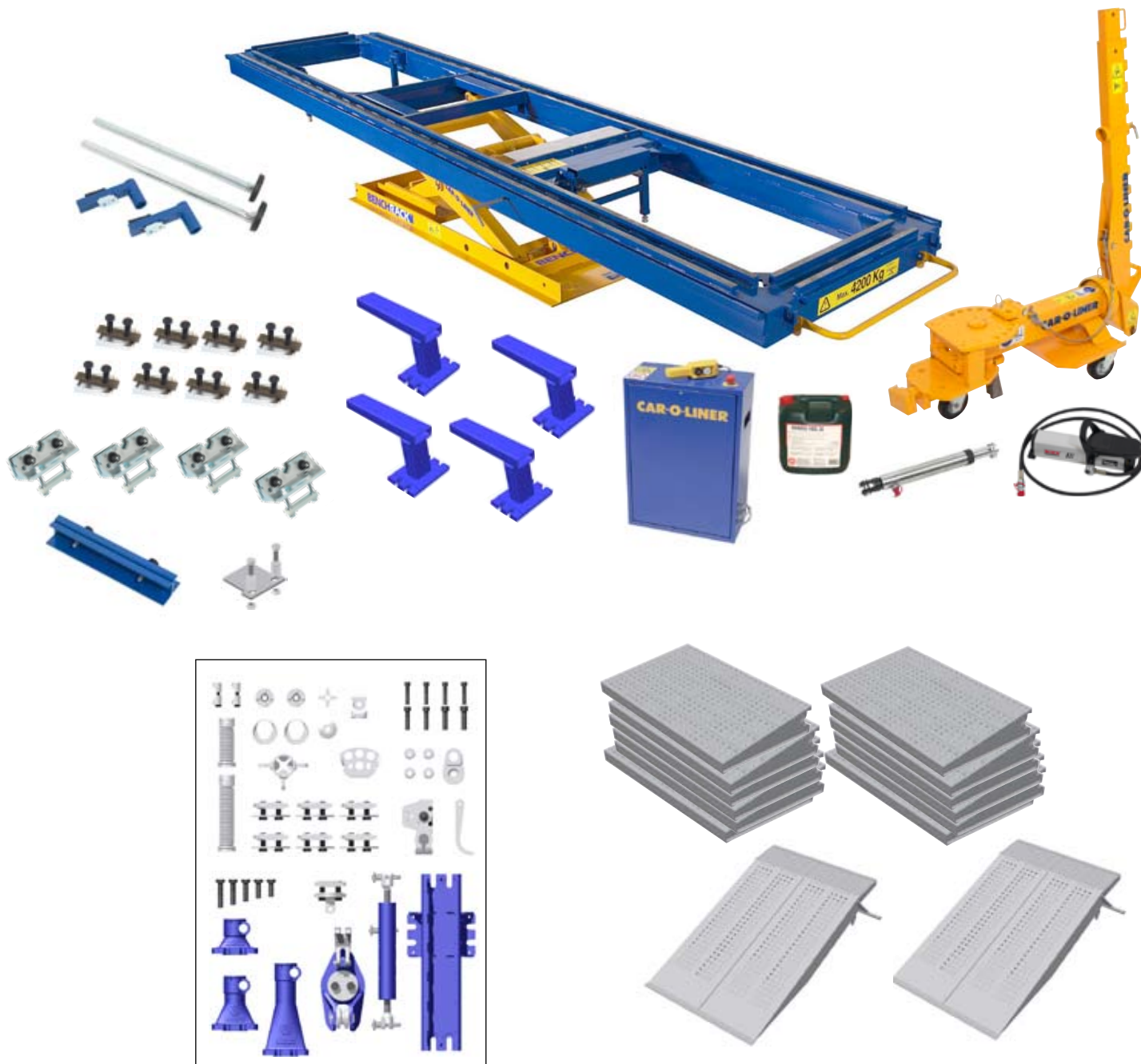

BenchRack 5500 Classic	Item	Art. No.	* Qty	Order
	B83 Base frame BR5500 w Lift	34640	1	
	B323 Ramp kit BR5500	31934	1	
	D16 Draw Aligner	30346	1	
	B61 Bench Parts BR std.	30948	1	
	B633 Pillar jack kit	34014	1	
	EVO1 Basic	35413	1	
	Power unit, Hydraulic oil. Se select 3			
	D160 NIKE cylinder w pump, D16	35886	1	



* = Recommended Quantity

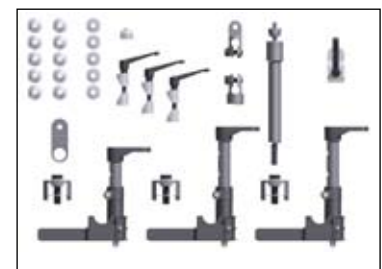
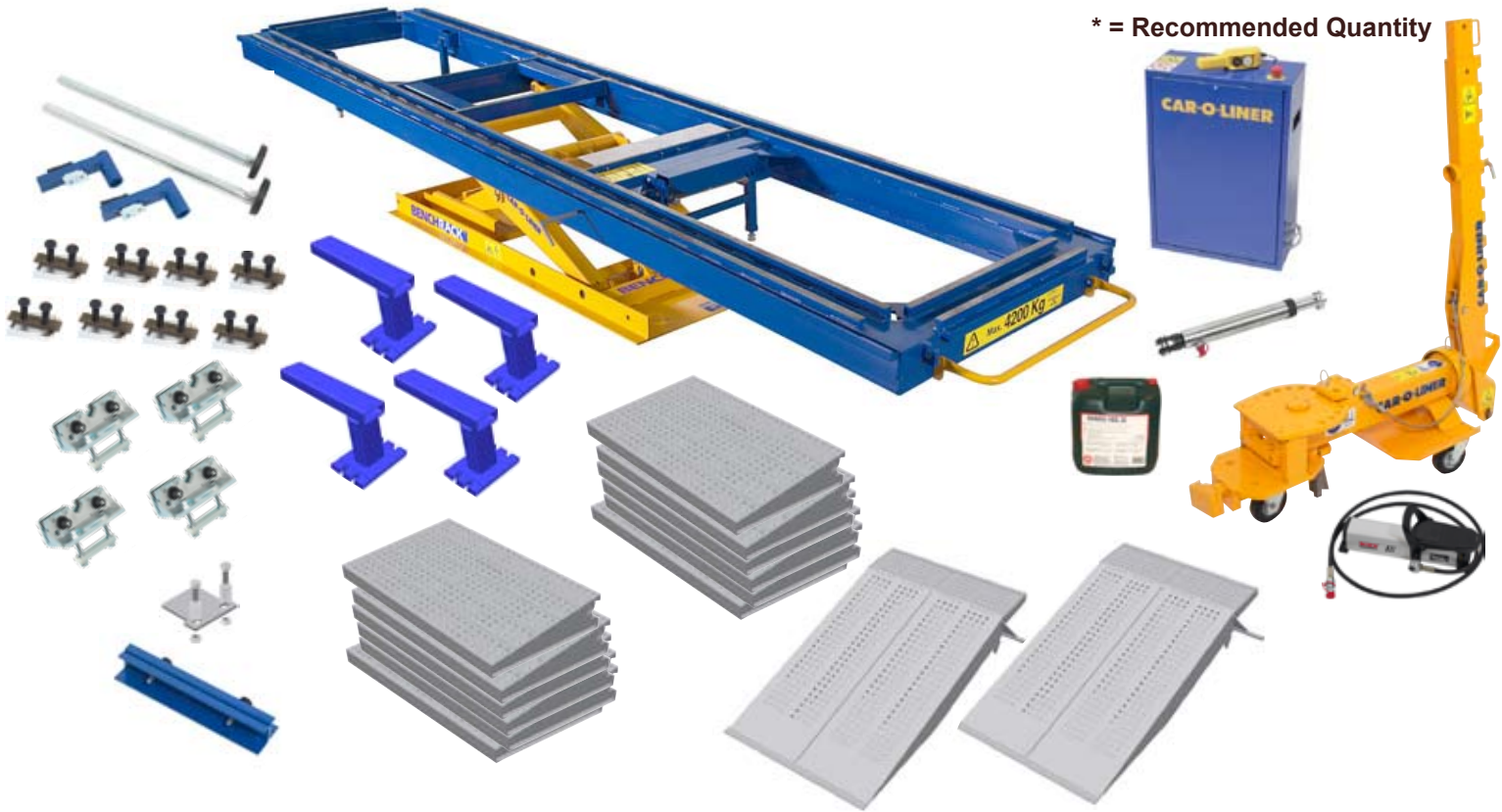

BenchRack 5500 Standard	Item	Art. No.	* Qty	Order
	B83 Base frame BR5500 w Lift	34640	1	
	B323 Ramp kit BR5500	31934	1	
	D16 Draw Aligner	30346	1	
	B61 Bench Parts BR std.	30948	1	
	B633 Pillar jack kit	34014	1	
	EVO1 Basic	35413	1	
	EVO2 Extension	35419	1	
	EVO3-1 Additional kit	35420	1	
Power unit, Hydraulic oil. Se Select 3				
	D160 NIKE cylinder w pump, D16	35886	1	



* = Recommended Quantity

Select 1	Platform	Art. No.	* Qty	Order
B81	B81 Base frame BR4200 w Lift	34573	1	
B16	B16 Base frame BR5000 w Lift	34639	1	
B83	B83 Base frame BR5500 w Lift	34640	1	
B84	B84 Base frame BR6300 w Lift	33907	1	



Select 2	Ramps	Art. No.	* Qty	Order
B322	B322 Ramp kit BR4200	31927	1	
B320	B320 Ramp kit BR5000	30984	1	
B323	B323 Ramp kit BR5500	31934	1	
B328	B328 Ramp kit BR5500 Wide	33989	1	
B325	B325 Ramp kit BR6300 Wide	33990	1	
T66	T66 Ramp Extension kit	40841	1	



Approach ramp

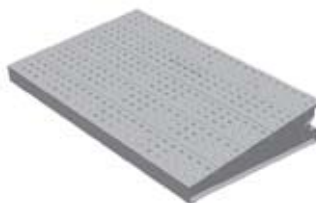

Ramp



T66 Extension kit

Select 3	Hydraulic	Art. No.	* Qty	Order
T611	T611 Power unit, 400V 3ph 50Hz + T655 Hydraulic oil	35879	1	
T612	T612 Power unit, 200V 3ph 50Hz + T655 Hydraulic oil	35880	1	
T613	T613 Power unit, 220V 3ph 50Hz + T655 Hydraulic oil	35881	1	
T614	T614 Power unit, 110V 1ph 60Hz + T655 Hydraulic oil	35882	1	
T615	T615 Power unit, 220V 1ph 60Hz + T655 Hydraulic oil	35883	1	





T655





* = Recommended Quantity

Select 4	Draw Aligner	Art. No.	* Qty	Order
D16				
	D16 Draw Aligner	30346	1	

	NIKE Hydraulic	Art. No.	* Qty	Order
D160				
	D160 NIKE cylinder w pump, D16	35886	1	

	CMO Hydraulic	Art. No.	* Qty	Order
D161				
	D161 CMO cylinder w pump, D16	35888	1	

Accessories	Draw Aligner	Art. No.	* Qty	Order
D90				
	D90 Down pull for D16	30412	1	
T35				
	T35 Chain kit 10 ton	35889	1	



* = Recommended Quantity

Select 5	Bench Parts	Art. No	* Qty	Order
B61	B61 Bench Parts BR std.	30948	1	

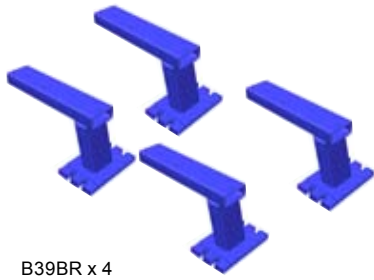

B39BR x 4



B626 x 8

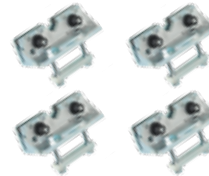

B106 X 4



B23



B46

	Bench Parts	Art. No	* Qty	Order
B633	B633 Pillar jack kit	34014	1	
T62	T62 Air Jack K22	30600	1	
B57	B57 Roll Stop / Loading Trolley	30872	2	



* = Recommended Quantity

Select 6	Bench Parts EVO Systems	Art. No	* Qty	Order
EVO1	EVO1 Basic	35413	1	



	Bench Parts EVO Systems	Art. No	* Qty	Order
EVO2	EVO2 Extension	35419	1	



	Bench Parts EVO Systems	Art. No	Qty	Order
EVO 3	EVO 3 Universal Fixture	35719	1	



* = Recommended Quantity

	Bench Parts EVO Systems	Art. No	* Qty	Order
EVO3-1	EVO3-1 Additional kit	35420	1	



* = Recommended Quantity

Accessories	Art. No	* Qty	Order
B73	B73 Basic Truck Clamping	35890	1

Accessories	Art. No	* Qty	Order
B730	B730 Truck Clamping	35891	1

Accessories B73/B730	Art. No	* Qty	Order
B340BR	B340BR Bench Mounting	35892	1



* = Recommended Quantity

Accessories		Art. No	* Qty	Order
T10	T10 Universal pulling hook	34638	1	



		Art. No	* Qty	Order
T11	T11 Accessories for T10	30541	1	



		Art. No	* Qty	Order
T70	T70 Pull Clamp kit	32000	1	



		Art. No	* Qty	Order
--	--	---------	-------	-------

T67	T67 Transport wagon	34318	1	
T61	T61 Winch cpl.	30970	1	
T43	T43 Roller trolley	32081	4	
T48	T48 Support stand	30669	2	
T53	T53 Multi-pad metal	30941	4	
T63	T63 Holder for multi-pad metal	30682	4	

Accessories		Hydraulic		
-------------	--	-----------	--	--

T250	T250 Cable protection	31040	1	
T251	T251 Cable protection 45°	33286	1	





www.car-o-liner.com

Means profitability for your business...



Box 7 • SE-736 21 Kungsör • Sweden. Telephone +46 227 412 00 • Telefax +46 227 319 00
www.car-o-liner.com • info@car-o-liner.se